

LSR SERIES Linear Light MULTI-DRIVE™

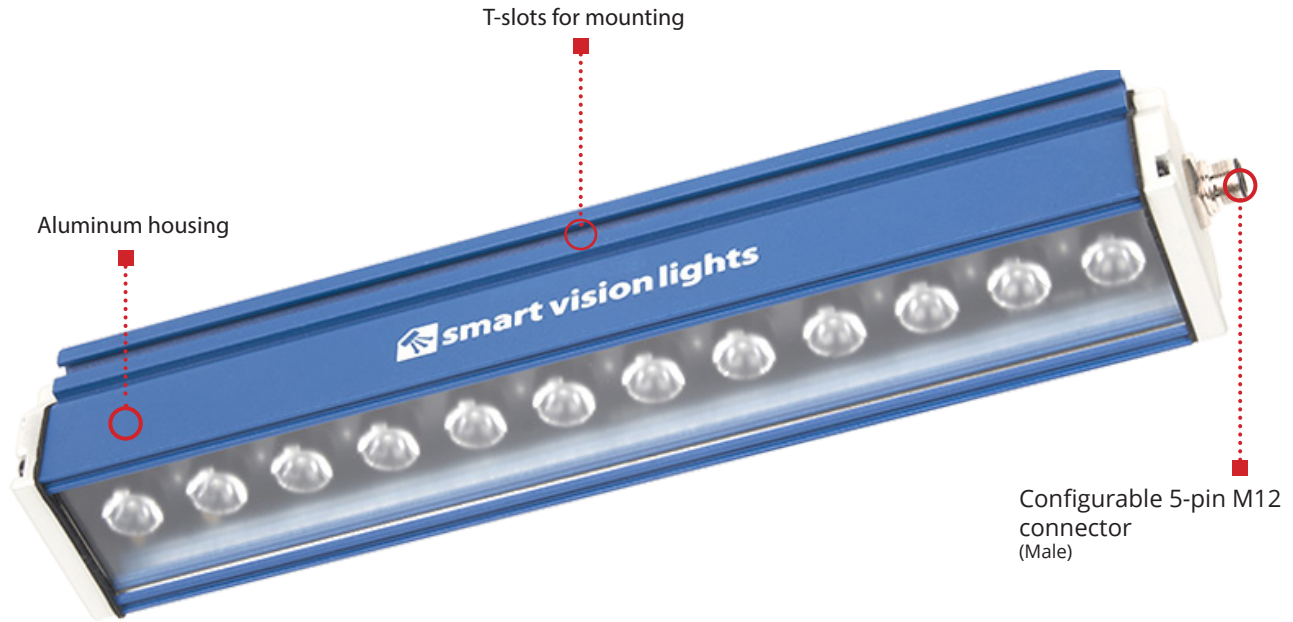

The LSR series is a SmartVisionLink™-enabled linear light that can produce over 340,000 lux and is offered in lengths up to 1200 mm. When used with the BTM-1000 Bluetooth accessory¹ and the SmartVisionLink™ app, the LSR Series can have its intensity remotely adjusted. The LSR Series is easily mounted with the built-in T-slot rail system.

LSR SERIES HIGHLIGHTS

Warranty 10 YEAR	Tested IEC 62471	Compliant CE ROHS	Rated IP 65	Connector 5-PIN M12
--------------------------------	--------------------------------	---------------------------------	---------------------------	-----------------------------------

- ✓ Multi-Drive™ provides the ability for either continuous or OverDrive™ strobe modes.
- ✓ SmartVisionLink™-enabled to allow for easy intensity adjustment in both continuous and OverDrive™ strobe modes.²
- ✓ IP65 sealed

¹ BTM-1000 sold separately

² Only while using the SmartVisionLink™ app



SPECIFICATIONS

	Continuous Operation	OverDrive Operation
Electrical Input	24 VDC +/- 5%	
Input Current	Max. 530 mA per 150 mm segment Max. 990 mA per 300 mm segment	Peak 2.5 A during strobe per 150 mm segment Peak 5.1 A during strobe per 300 mm segment
Input Power	Max. 12.7 W per 150 mm segment Max. 23.8 W per 300 mm segment	Peak 60 W during strobe per 150 mm segment Peak 122 W during strobe per 300 mm segment
PNP Trigger	2 mA @ 4 VDC 7 mA @ 12 VDC 13.4 mA @ 24VDC	
NPN Trigger	12 mA @ Common (0VDC)	
Trigger Input	PNP > +4 VDC (24 VDC max.) to activate or NPN > GND (<1VDC) to activate (not both)	PNP > +4 VDC (24 VDC max.) to activate or NPN > GND (<1VDC) to activate (not both)
Mode Control	Connect pin 5 to 1-10 VDC (10 - 100% output); 24 VDC (Max)	Connect pin 5 to GND (See wiring configuration for more information)
Strobe Duration	Min. 10 μ s Max. ∞	Min. 10 μ s Max. 50 ms
Strobe Trigger Latency	10 μ s	6 μ s
Strobe Frequency	Max 4 kHz or 1 / Duty Cycle as calculated, whichever is less. ¹	
Duty Cycle	Not applicable	Max. 10% ¹
Analog Intensity	The output is adjustable from 10% - 100% of intensity limit by a 1 - 10 VDC signal. Jumpering pin 5 to pin 1 will provide maximum intensity. Intensity limit can be remotely adjusted via SmartVisionLink™ ²	
Connection	5-pin M12 connector	
Operating Temperature	-10° to 40° C (14° to 104° F) RH max 80% non-condensing humidity	
Storage Temperature	-20° to 70° C (-4° to 158° F) RH max 80% non-condensing humidity	
IP Rating	IP65	
Weight	LSR150: 1.0 lbs (~454 g) LSR300: 1.8 lbs (~816 g) LSR450: 2.6 lbs (~1.18 kg) LSR600: 3.2 lbs (~1.45 kg) LSR900: 4.8 lbs (~2.17 kg) LSR1200: 6.5 lbs (~2.95 kg)	
Compliances	CE, IEC-62471, RoHS	
Warranty	10 years ³	

¹See page 6 for more information

²SmartVisionLink™ requires the purchase of the BTM-1000 bluetooth module, sold separately, and the SmartVisionLink™ app, free to download on the Apple App and Google Play stores.

³See SmartVisionLights.com/warranty for details.

WIRING CONFIGURATION

CONTINUOUS OPERATION MODE

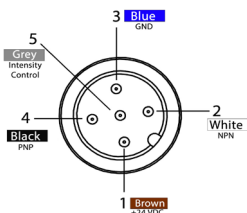

Pin layout for light (Male Connector)

Pins	Function	Signal	Wire Color
1	Power In	+24VDC	BROWN
2	NPN	Sinking Signal	WHITE
3	GND	Ground	BLUE
4	PNP	Sourcing Signal	BLACK
5	Intensity Control	1-10VDC	GREY

For maximum intensity, tie pin 5 to pin 1 at +24 VDC.

For continuous mode: PNP (pin 4) can be tied to +24 VDC (pin 1) **or** NPN (pin 2) can be tied to Ground (pin 3).

For proper light function, apply either a PNP or NPN signal, not both.

Failure to supply light with correct input current will result in inconsistent lighting behavior.

(see Product Specifications for requirements)

WIRING CONFIGURATION (continued)

OVERDRIVE™ OPERATION MODE

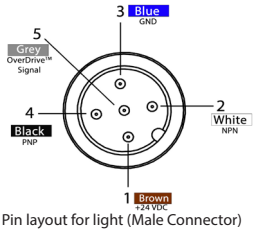

Pins	Function	Signal	Wire Color
1	Power In	+24VDC	BROWN
2	NPN	Sinking Signal	WHITE
3	GND	Ground	BLUE
4	PNP	Sourcing Signal	BLACK
5	OverDrive™ Signal	Ground	GREY

To enable OverDrive™ mode, tie pin 5 to pin 3.

For proper light function, apply either a PNP or NPN signal, not both.

Failure to supply light with correct input current will result in inconsistent lighting behavior.

(see Product Specifications for requirements)

LIGHTING PATTERNS

The LSR Series is recommended to be used at a working distance between 300 mm to 2000 mm. Illuminance values taken using the LSR300 on white light - 5700K

Standard (10°) lighting patterns

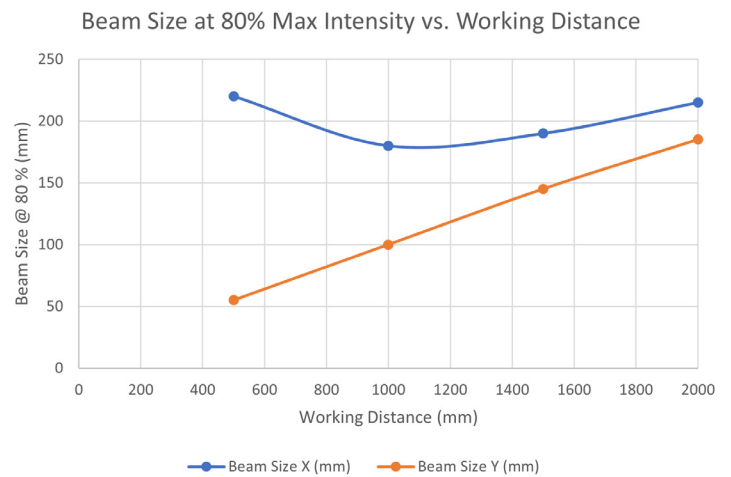
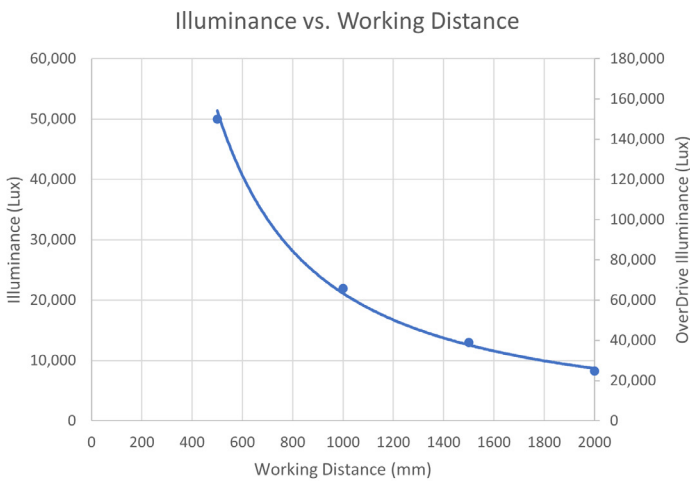

Wide (30°) lighting patterns

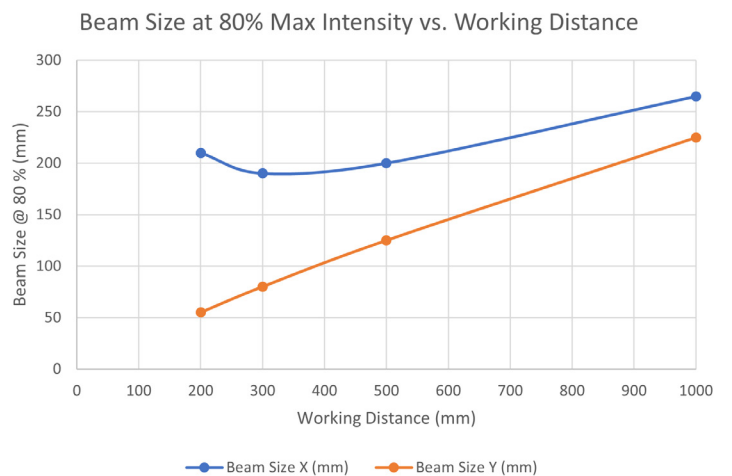
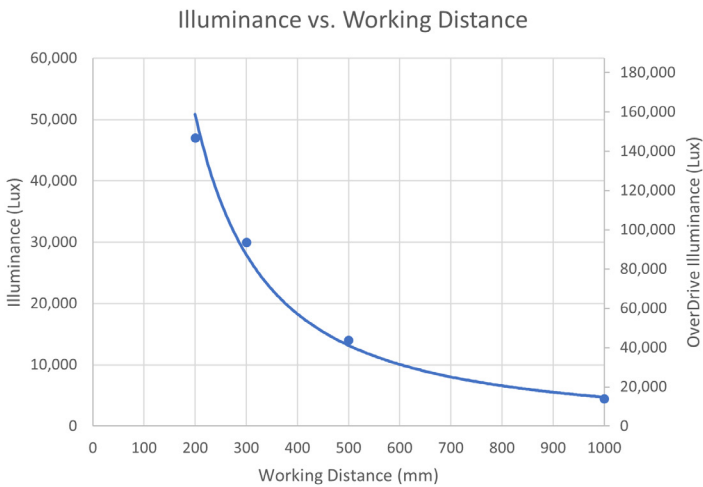

LIGHTING PATTERNS (continued)

Line (10° x 50°) lighting patterns

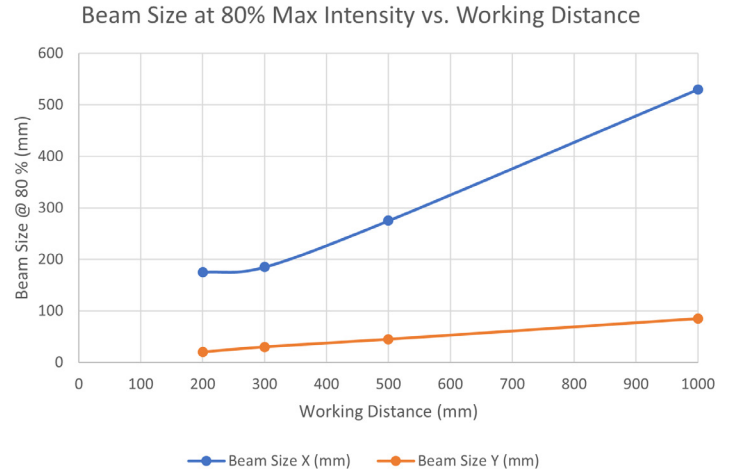
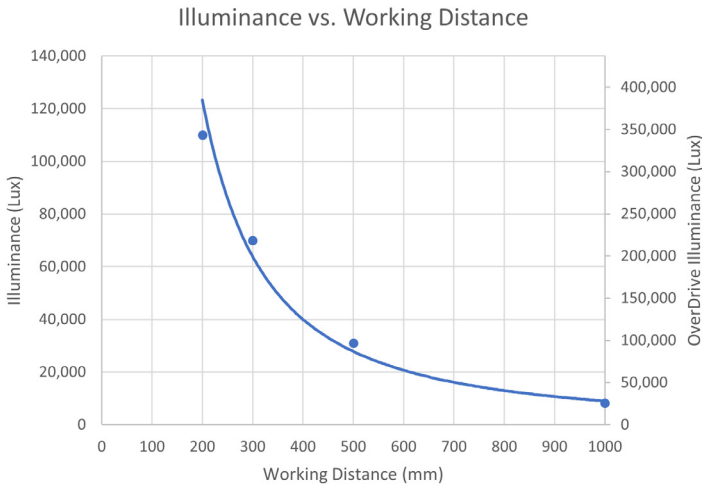

BEAM PATTERNS

The LSR Series is recommended to be used at a working distance between 300 mm to 2000 mm. Illuminance values taken using the LSR300 on white light - 5700K

Standard (10°) beam patterns

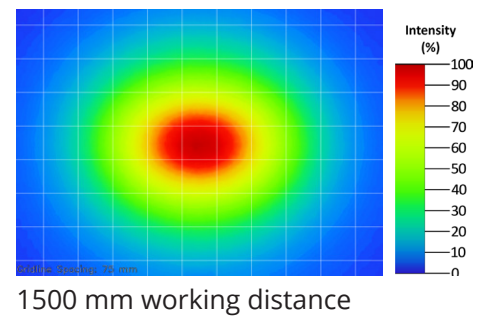
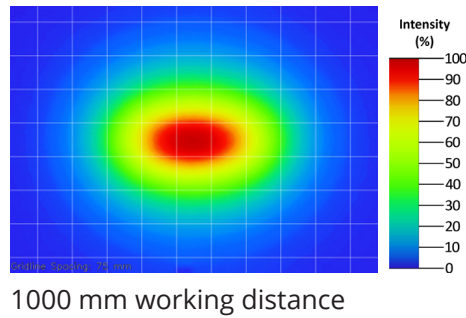
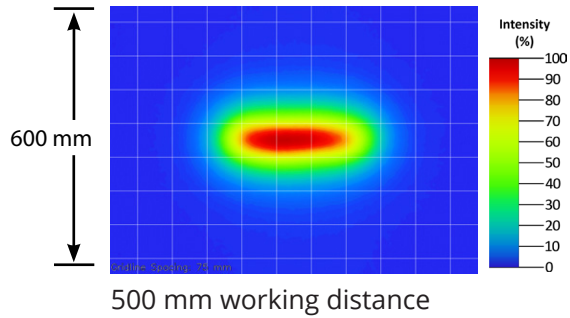

Wide (30°) beam patterns

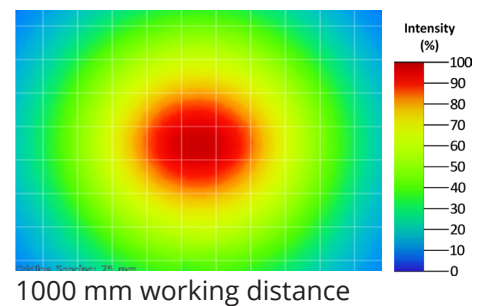
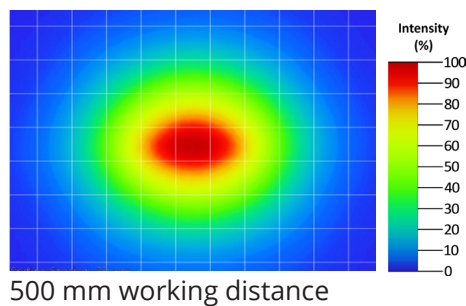
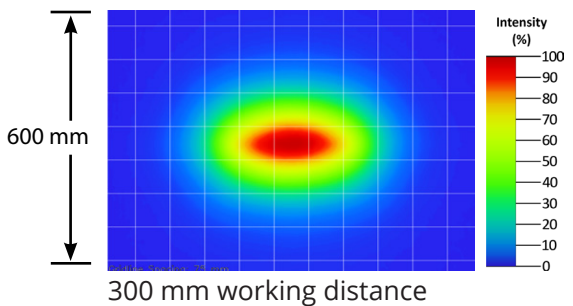

BEAM PATTERNS (continued)

Line (10° x 50°) beam patterns

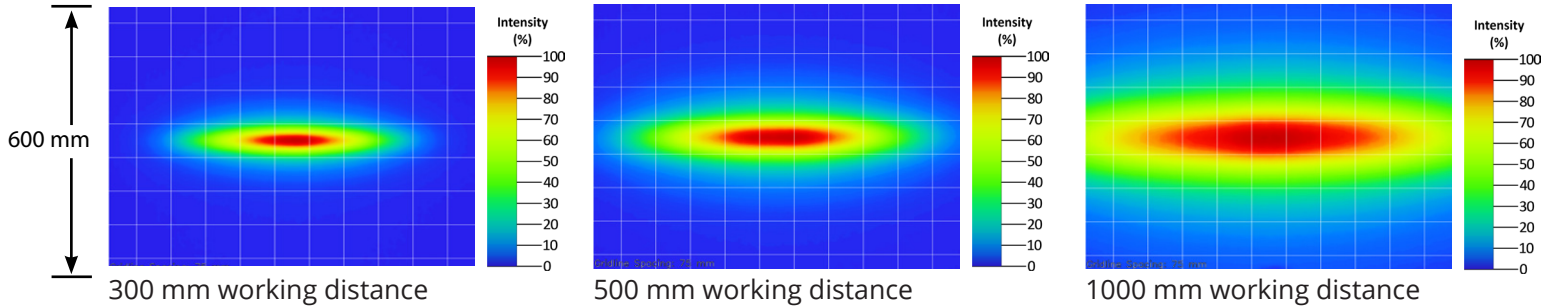

LENS OPTICS

NARROW (Standard)

The standard lens option uses a 10° beam angle lens. Standard lenses create a narrow beam of illumination and are used for long working distances.



LINE

The line lens option uses a 10° x 50° beam angle lens. They project a thin, narrow beam of illumination.

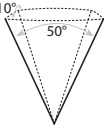

WIDE

The wide lens option uses a 30° beam angle lens. They create a floodlight effect and can be used for short working distances.



MOUNTING

T-slots are located along the bottom and sides of the LSR Series light.

The LSR comes with two T-bolts, two washers, and two nuts

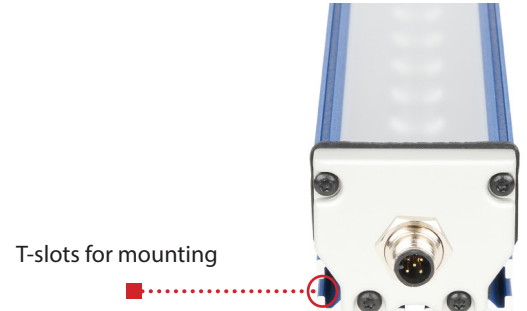

EYE SAFETY

According to IEC 62471:2006. Full documentation available upon request.

Notice

Exempt Group: No photobiological hazard to eyes or skin even for continuous, unrestricted use. Applicable for wavelengths 625, 850, and 940.

Caution

Risk Group 1: Possibly hazardous optical radiation emitted from this product. Do not stare at operating lamp. May be harmful to eyes. Safe for most applications except prolonged exposure. Applicable for wavelengths 470, 530, and WHI.

Caution

Risk Group 2: UV emitted from this product. Eye or skin irritation may result from exposure. Use appropriate shielding. Applicable for wavelengths 365 and 395.

ILLUMINATION

The LSR series works best for:

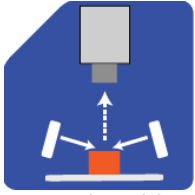

Dark Field

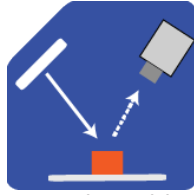

Bright Field

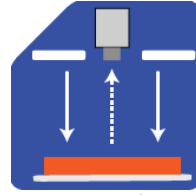

Direct Lighting

DUTY CYCLE

This section applies only if light is in OverDrive™ strobe mode.

The Duty Cycle (D) is related to the Strobe Time (ST) and Rest Time (RT).

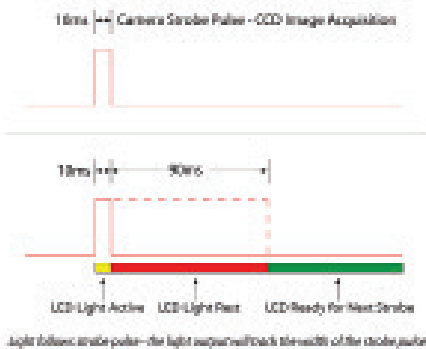

Calculating Rest Time

$$RT = \frac{ST}{D} - ST$$

RT = Rest Time
ST = Strobe Time
D = Duty Cycle

Example

$$90 \text{ ms} = \frac{10 \text{ ms}}{.1} - 10 \text{ ms}$$

Rest Time is 90 ms for 10 ms Strobe Time

Calculating Strobe Rate

$$SR = \frac{D}{ST}$$

SR = Strobe Rate (strokes per second)
ST = Strobe Time (seconds)
D = Duty Cycle

Example

$$1000 = \frac{0.1}{0.0001}$$

Strobe Rate is 1000 strokes per second

Calculating Duty Cycle

$$D = ST \times SR$$

SR = Strobe Rate (strokes per second)
ST = Strobe Time (seconds)
D = Duty Cycle

Example

$$0.1 = 0.0001 \times 1000$$

Duty Cycle is 10% (0.1)

Maximum Duty Cycle for OverDrive™ light is 10% (0.1)

Maximum Strobe Frequency is $\frac{1}{\text{calculated duty cycle}}$ or 4,000 strokes per second, whichever is less.

MULTI-DRIVE™

Multi-Drive™ provides both continuous and OverDrive™ modes from a single integrated driver. Users can select the lighting mode via the input wiring configuration. With OverDrive™, the light can be strobed at up to 10 times the intensity* of continuous mode.

*See lighting section for more information on this light's OverDrive values.



SAFESTROBE™

SafeStrobe™ is a unique technology that applies safe working parameters to ensure high current LEDs are not damaged by driving them beyond their limits, such as maximum strobe time or duty cycle. This is especially beneficial for overdriving our high current LEDs.

SMARTVISIONLINK™

The LSR Series is SmartVisionLink™-enabled and is designed so the intensity limit can be adjusted using the SmartVisionLink™ app*.

SmartVisionLink™ provides a way for a light to communicate with an app on a mobile device or tablet. This technology allows users to adjust the intensity of the light in both continuous operation and OverDrive™ strobe mode. By connecting the BTM-1000 Bluetooth module to a light that is SmartVisionLink™-enabled, a user can adjust parameters for the light. The SmartVisionLink™ app is available free to download in the Apple App and Google Play Stores.

Visit SmartVisionLights.com/SmartVisionLink for more information.

*Requires the purchase of the BTM-1000 bluetooth module, sold separately.



CONNECTING A BTM-1000

The BTM-1000 can be connected directly to a light or attached to a jumper cable that is connected to a light. Once the light's intensity is set to a desired level, the BTM-1000 can be removed from the light or cable.

The pigtail end of the BTM-1000 is connected directly to the light or to the cable attached to the light - sold separately.



PART NUMBER GUIDE

LSR - - -

SIZE:
 150 mm
 300 mm
 450 mm
 600 mm
 900 mm
 1200 mm

COLOR:

LENS:
 Leave blank for Standard (Narrow, 10°)
 W = Wide (30°)
 L = Line (10° x 50°)

LINEAR POLARIZER:
 Leave blank for none
 LPI = Factory Installed

Additional wavelengths and lens options available upon request.
 *For lights with lenses, running in continuous operation while using a linear polarizer with certain wavelengths (e.g., white, blue) may burn the polarizer. Incorrect usage of the polarizer is not covered by warranty.

Part Number Examples:

LSR300-625 LSR, 300 mm, 625 nm Red Wavelength, Standard lens angle

LSR600-WHI-W LSR, 600 mm, White Wavelength, Wide lens angle

ACCESSORIES

Power Cables



Lengths	Part Number
5 m	5PM12-5
10 m	5PM12-10
15 m	5PM12-15

Mount



Description	Part Number
3-Axis Pan and Tilt Mount	PB300-M5

SmartVisionLink™



Description	Part Number
Bluetooth Module	BTM-1000

Mounting Kit



Description	Part Number
M5x12 mm T-bolt	SC0161
Stainless Steel Nycon Insert Lock Nut	NU0022
Stainless Steel Flat Washer	WA0018

Light comes with two T-bolts, two nuts, and two washers.

Linear Polarizer



Description	Part Number
LSR300 Linear Polarizer Kit	LTF300-LP
LSR600 Linear Polarizer Kit	LTF600-LP
LSR900 Linear Polarizer Kit	LTF900-LP

Linear polarizer not available for the LSR1200

PRODUCT DRAWINGS (LSR150)

CAD files available on our website. Drawings are in mm.

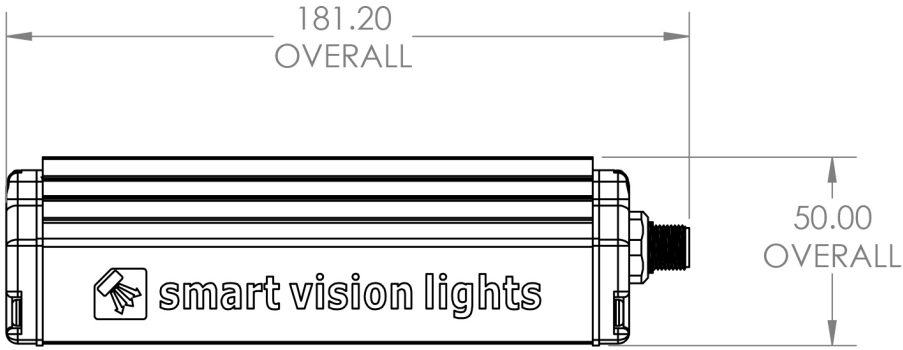

TOP

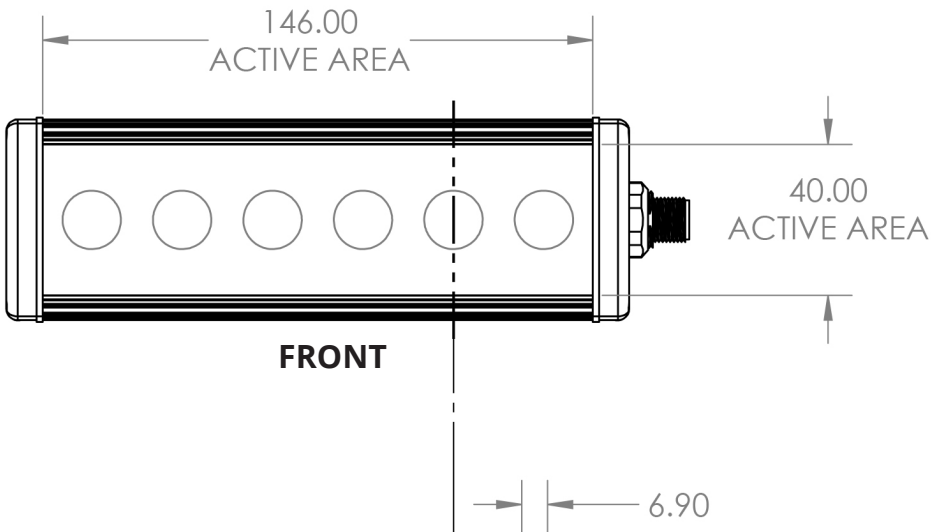

FRONT



RIGHT

PRODUCT DRAWINGS (LSR300)

CAD files available on our website. Drawings are in mm.

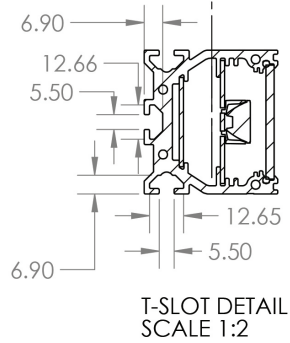
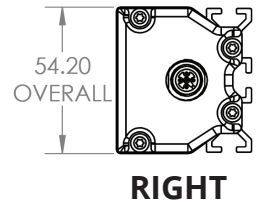
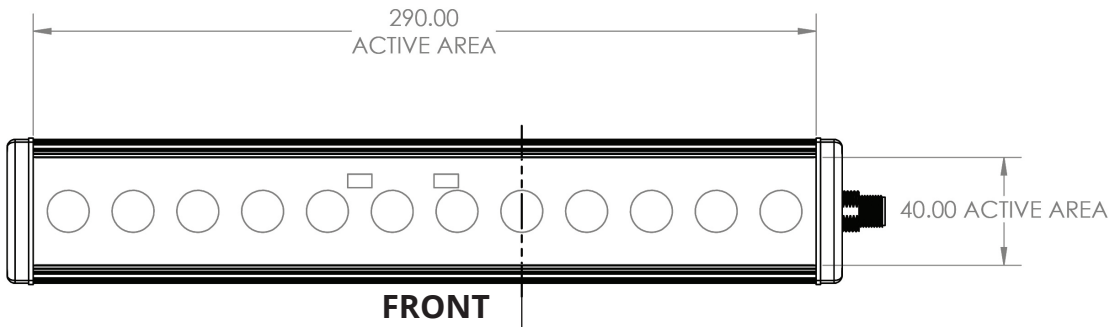

PRODUCT DRAWINGS (LSR450)

CAD files available on our website. Drawings are in mm.



TOP

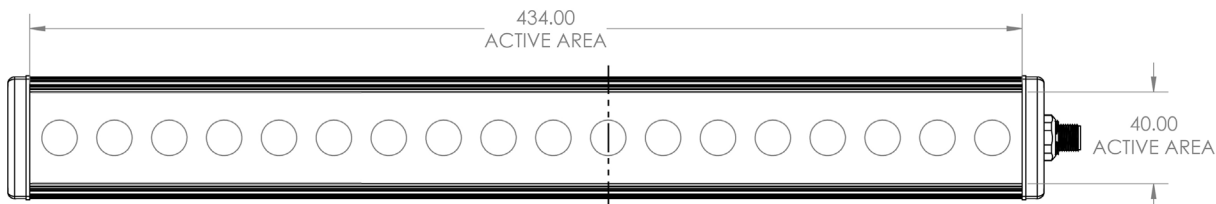

FRONT

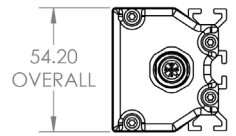

RIGHT

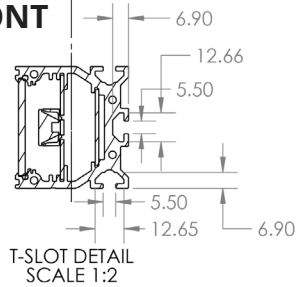

PRODUCT DRAWINGS (LSR600)

CAD files available on our website. Drawings are in mm.

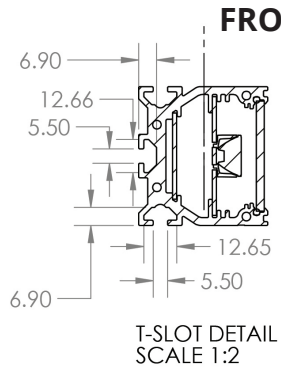
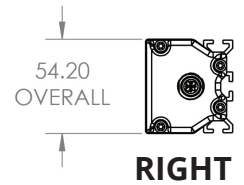
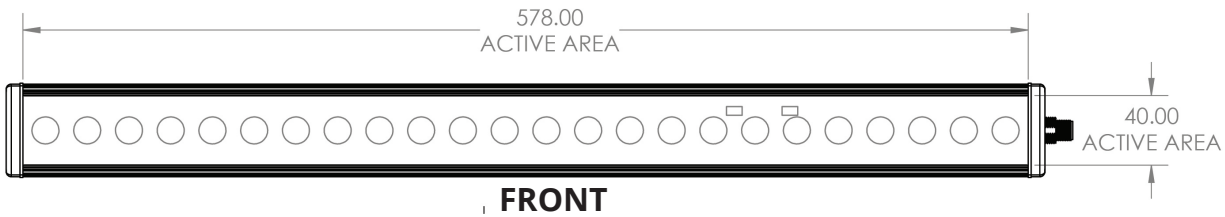
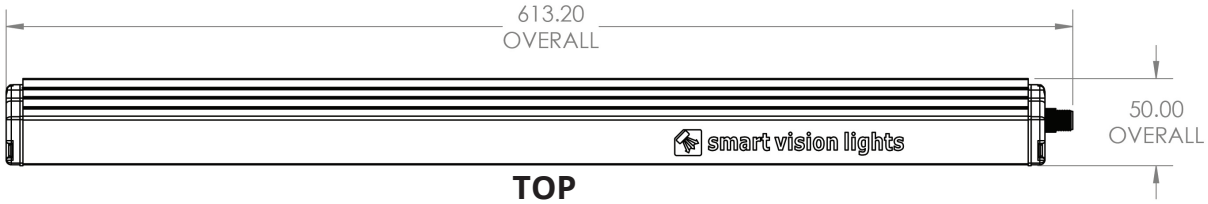

PRODUCT DRAWINGS (LSR900)

CAD files available on our website. Drawings are in mm.

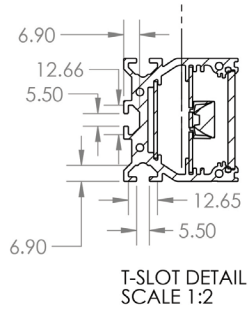
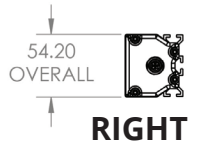
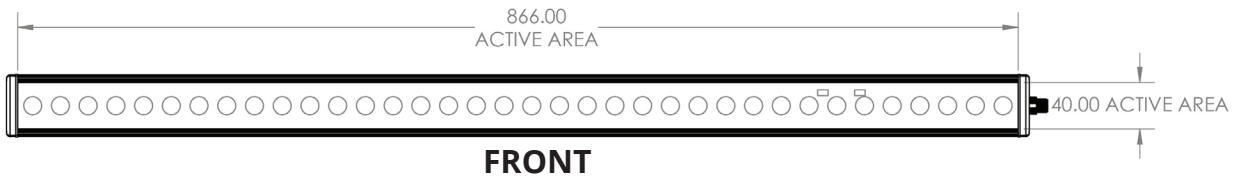
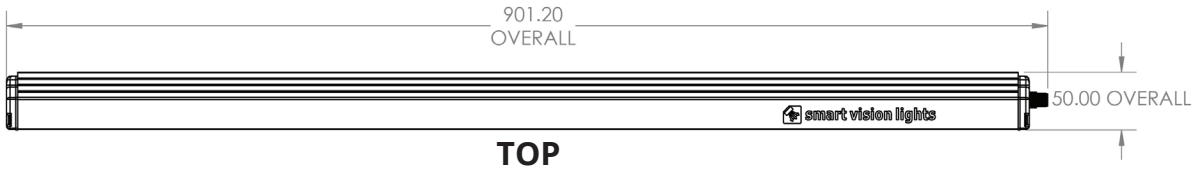

PRODUCT DRAWINGS (LSR1200)

CAD files available on our website. Drawings are in mm.

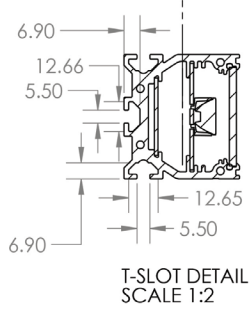
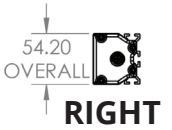
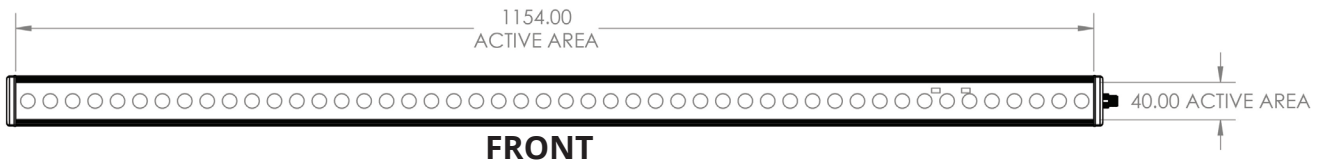

GLOSSARY

This glossary covers all Smart Vision Lights product families; some content in this section may not apply to this specific light.

TERMINOLOGY

Continuous Operation The light stays on continuously.

OverDrive™ Integrated driver that produces a high-current strobe to the LEDs to drive them beyond their nominal continuous operation output.

Multi-Drive™ Integrated driver that combines continuous operation and OverDrive™ strobe mode

NanoDrive™ Integrated driver that provides fast switching where the light can go from off to on in less than 500 ns.

Built-in Driver The driver contained within the light that controls the current to the LEDs and provides PNP, NPN, and analog dimming controls.

SmartVisionLink™ Integrated feature that enables lighting control through the Bluetooth module and app.

Camera to Light Connect the light directly to the camera, without the need for additional controllers or equipment.

Polarizers Filters that reduce reflections on specular surfaces.

Diffusers Widens the angle of emission by scattering light in all directions.

Pattern Area Lighting Modulated lighting pattern placed over a backlight's surface used to enhance defect detection on transparent and glossy surfaces

SafeStrobe Limiter to keep the light in safe working parameters.

Direct Connect Connect lights in a series without the use of cables.

Daisy-Chain Connect lights in a series with the use of cables.

TYPES OF ILLUMINATION

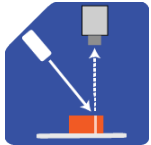

Projector

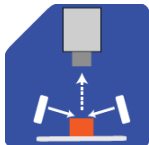

Dark Field

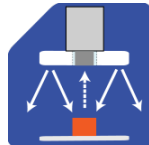

Radial



Bright Field

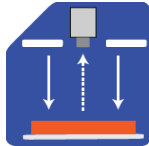

Direct

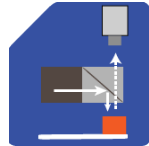

Axial

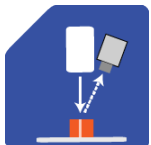

Line

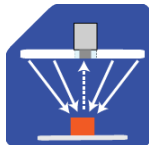

Diffuse Panel

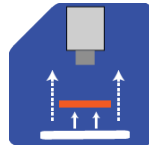

Backlight

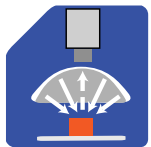

Dome
"Light Tent"

COMMON COLOR / WAVELENGTHS LEGEND

Wavelength options range from 365 nm to 1650 nm.*
Additional wavelengths available for many light families.

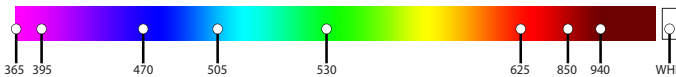

*See Part Number section for **this light's** available standard wavelengths.



Shortwave Infrared LEDs are available in 1050 nm, 1200 nm, 1300 nm, 1450 nm, 1550 nm, and 1650 nm.*

*Check Part Number section to see if **this light** is available in SWIR wavelengths.



ISO 9001:2015 Certified QMS