

# Basler Accessories



## Technical Specification

### **BASLER LENS C125-0418-5M**

**Order Number**

**2000034830**

Document Number: DG001465

Version: 02 Language: 000 (English)

Release Date: 28 April 2016

## **Contacting Basler Support Worldwide**

### **Europe, Middle East, Africa**

Basler AG  
An der Strusbek 60–62  
22926 Ahrensburg  
Germany

Tel. +49 4102 463 515  
Fax +49 4102 463 599

[support.europe@baslerweb.com](mailto:support.europe@baslerweb.com)

### **The Americas**

Basler, Inc.  
855 Springdale Drive, Suite 203  
Exton, PA 19341  
USA

Tel. +1 610 280 0171  
Fax +1 610 280 7608

[support.usa@baslerweb.com](mailto:support.usa@baslerweb.com)

### **Asia-Pacific**

Basler Asia Pte. Ltd.  
35 Marsiling Industrial Estate Road 3  
#05–06  
Singapore 739257

Tel. +65 6367 1355  
Fax +65 6367 1255

[support.asia@baslerweb.com](mailto:support.asia@baslerweb.com)

[www.baslerweb.com](http://www.baslerweb.com)

**All material in this publication is subject to change without notice and is copyright Basler AG.**

# Table of Contents

- 1 Key Features .....2**
- 2 Terms and Conventions .....3**
- 3 Mechanical Specifications and Environmental Requirements .....4**
- 4 Optical Specifications.....5**
- 5 Performance Charts.....6**
- 6 Example Images.....7**
- Revision History .....8**

# 1 Key Features

Key Features	
<ul style="list-style-type: none"><li>• Compact 5 megapixel lens for machine vision / factory automation</li><li>• Part of the Basler C125 lens series: 4, 6, 8, 12, 16, and 25 mm focal length models available</li><li>• Metal housing</li><li>• C-Mount interface</li><li>• Locking screws for iris and focus</li><li>• Low ghosting and veiling glare</li><li>• High contrast</li><li>• Accurate focusing mechanism</li></ul>	
Optimum working distance	0.5 m
Aperture range	<i>f/1.8 to f/22</i>
Focal length	4 mm
Order number	2000034830

## 2 Terms and Conventions

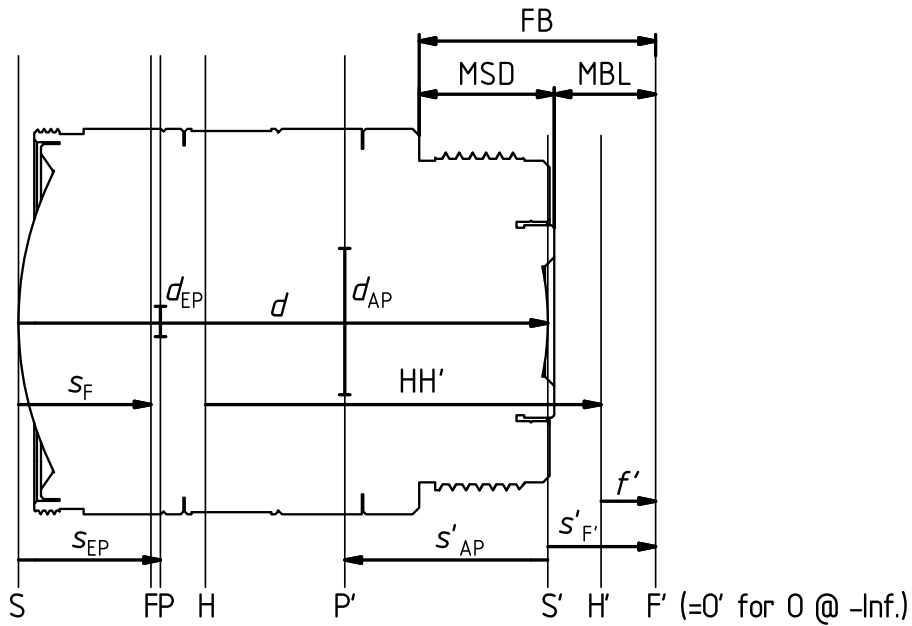

Figure 1: Terms for Lenses

Designations according to DIN 1335			
O	Object position	$f'$ (=HF')	Focal length
O'	Image position	$k$ ( $=f'/d_{EP}$ )	f-number (indicated as "f/k")
H	Front principal plane	$i$ (=HH')	Principal point separation
H'	Back principal plane	$s_F$ (=SF)	Front focal length
F	Front focal plane	$s'_{F'}$ (=S'F')	Back focal length
F'	Back focal plane	$s_{EP}$ (=SP)	Entrance pupil position
P	Entrance pupil plane	$s'_{AP}$ (=S'P')	Exit pupil position
P'	Exit pupil plane	$d$ (=SS')	Overall optical length
S	Vertex of first lens surface	$d_{EP}$	Entrance pupil diameter
S'	Vertex of last lens surface	$d_{AP}$	Exit pupil diameter
		$\beta'_P$ ( $=d_{AP}/d_{EP}$ )	Pupil magnification
Other Designations			
FB	Flange back	MOD	Minimum object distance
MSD	Maximum screw-in depth	CRA	Chief ray angle
MBL	Mechanical back length	Inf.	Infinity
WD	Working distance	MTF	Modulation transfer function

### 3 Mechanical Specifications and Environmental Requirements

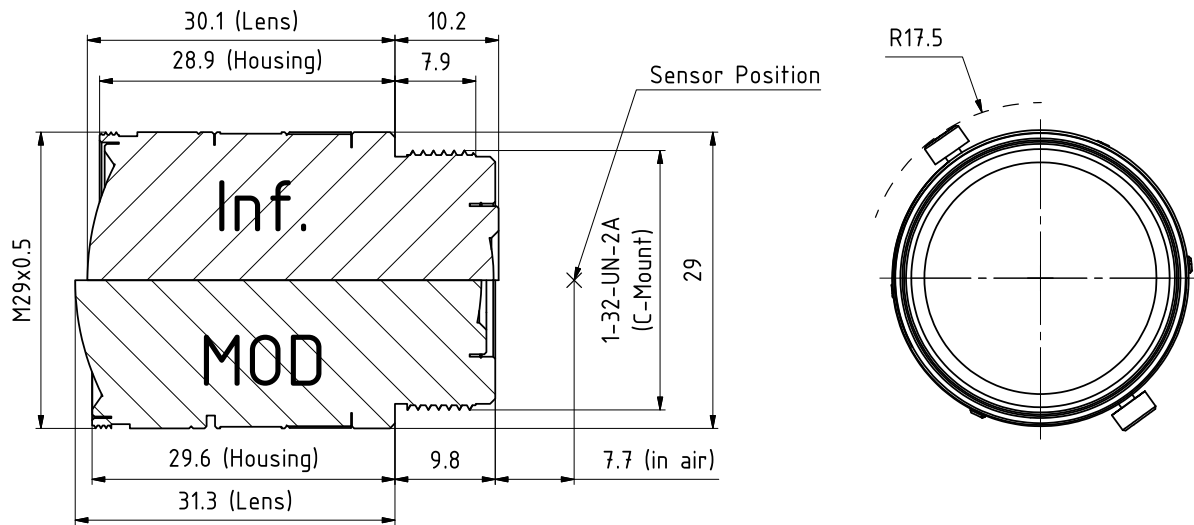

Figure 2: Mechanical Dimensions (in mm)

Mechanical Specifications	
Storage conditions	-20 °C to +60 °C, 35 % to 90 % relative humidity, non-condensing
Environmental requirements	-10 °C to +50 °C, 35 % to 90 % relative humidity, non-condensing (For best results, please focus when a steady operating temperature has been reached.)
Flange back	17.526 mm +0/-0.2 mm
Weight	Approx. 55 g
Focus operation	Manually Operating angle: 288°

## 4 Optical Specifications

Optical Specifications		
Focal length $f'$		4.09 mm $\pm$ 5 %
Aperture range		$f/1.8$ to $f/22$
Image circle		7.3 mm (1/2.5" format)
Focus range		0.1 m to infinity
Optimum working distance		0.5 m
Optimum magnification		0.008
Relative illumination at full aperture		At least 55 % (see Figure 3)
Resolution (25 % MTF, center, full aperture)		Designed for 230 LP/mm (2.2 $\mu$ m pixel size, see Figure 6)
Resolution at 5.8 mm image diagonal (80 % of a Basler acA2500-14xx camera)		At least 50 % of resolution in image center
Optical distortion		Typical -18 % (barrel distortion, see Figure 4)
Angle of view, 1/2.5" format (using a Basler acA2500-14xx camera)	horizontal	76.0° (@ MOD) to 76.4°
	vertical	58.2° (@ MOD) to 58.5°
Angle of view, 1/3" format (using a Basler acA1300-30xx camera)	horizontal	65.6° (@ MOD) to 66.0°
	vertical	49.6° (@ MOD) to 49.9°
Wavelength range		Visible (400 to 700 nm, see Figure 5)
Pupil magnification $\beta'_P$		4.84
Chief ray angle, CRA		8.6°
Front focal length, $s_F$		9.95 mm
Back focal length, $s'_F$		8.09 mm
Principal point separation, HH'		29.71 mm
Entrance pupil position, $s_{EP}$		10.66 mm
Exit pupil position, $s'_{AP}$		-15.24 mm
Overall optical length, $d$		39.74 mm

## 5 Performance Charts

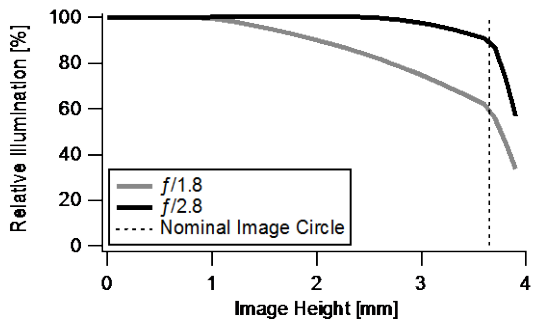

Figure 3: Relative Illumination vs. Image Height

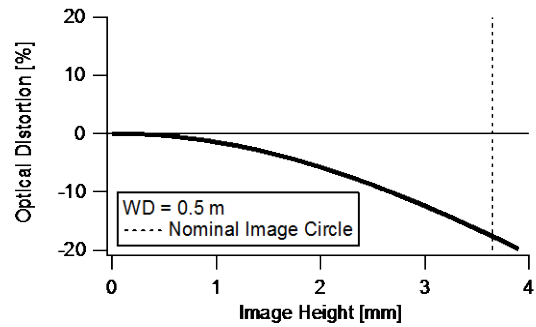

Figure 4: Distortion vs. Image Height

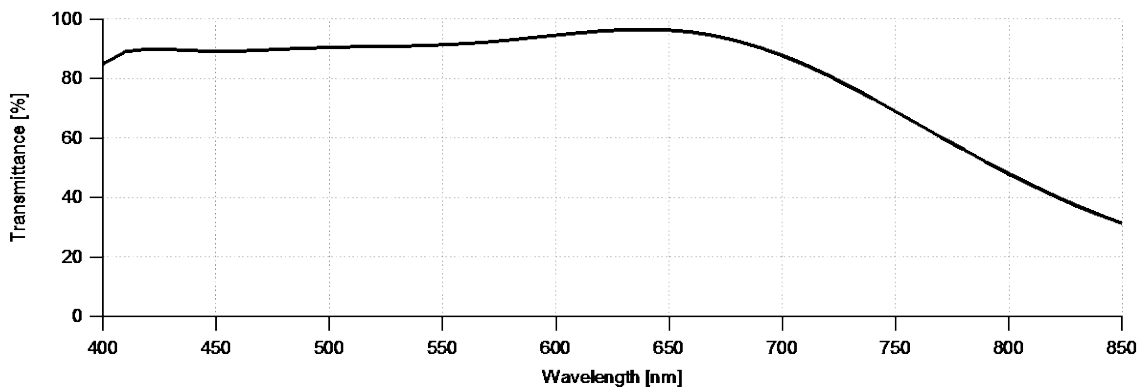

Figure 5: Transmittance

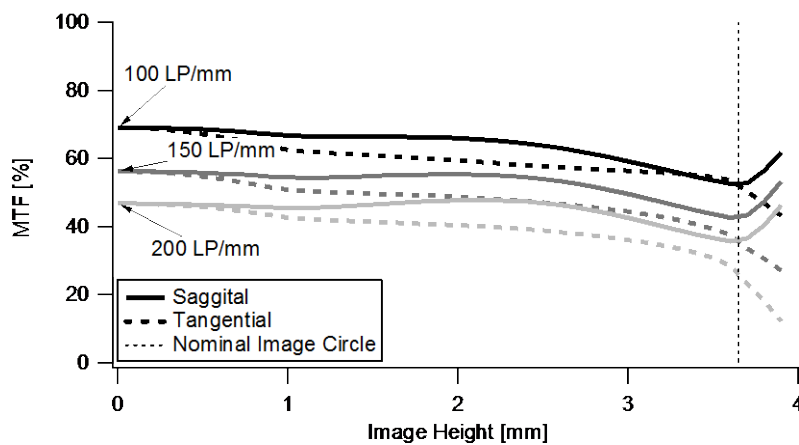

Figure 6: Resolution vs. Image Height

Conditions for MTF calculation:  $f/1.8$ , polychromatic, 0.5 m working distance

The technical data shown in chapters 1 to 5 are Nominal Design Values. The real values of the delivered products may deviate from the Nominal Design Values.



## 6 Example Images

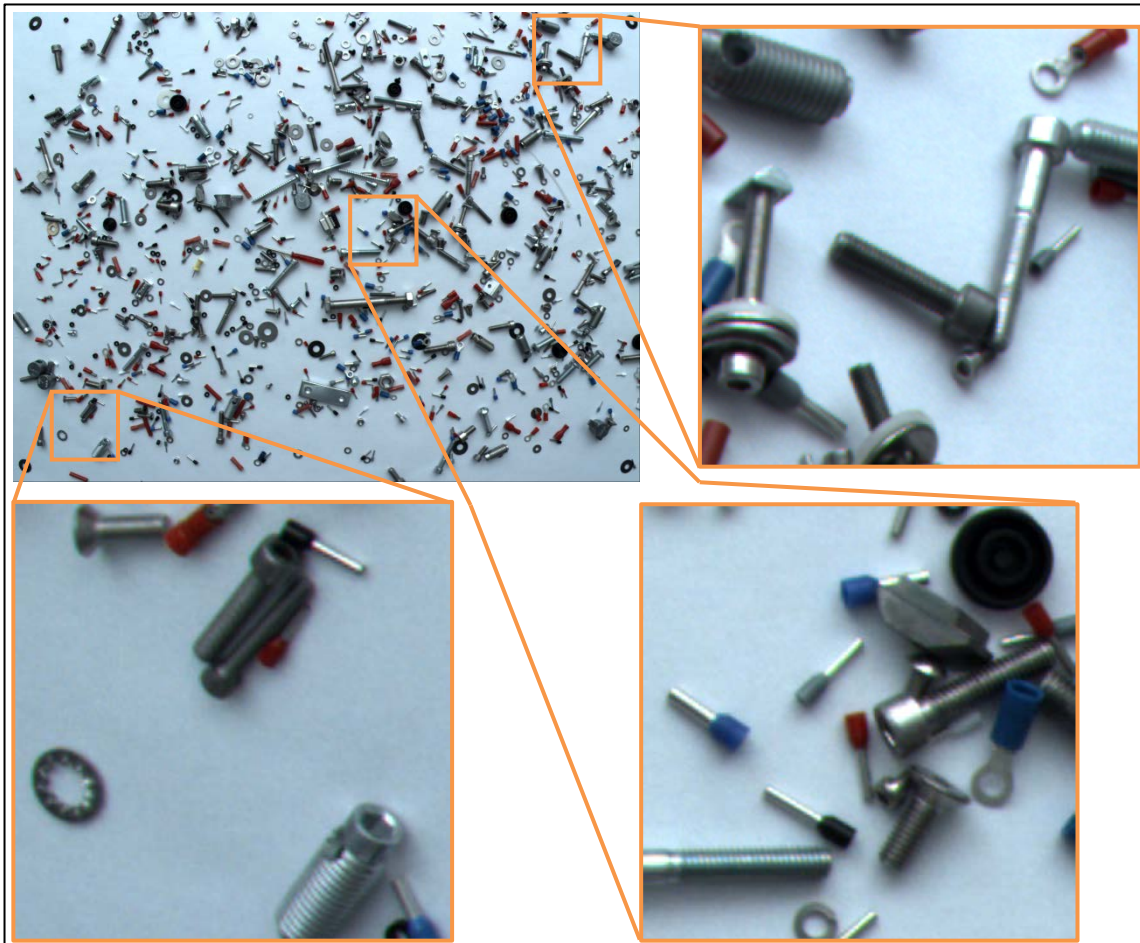

Figure 7: acA2500-14gc,  $f/2.8$ , 0.5 m Working Distance, Full 5 Megapixel Image and Selected Magnified Sections

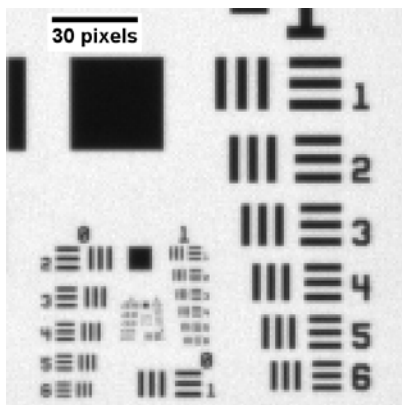

Figure 8: USAF1951 Target, Center

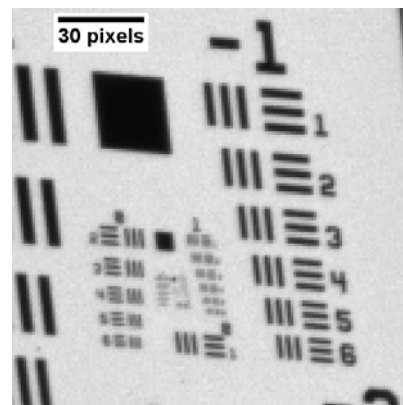

Figure 9: USAF1951 Target, Corner

- Image taken with a Basler acA2500-14gm camera
- 0.5 m working distance
- $f/2.8$ , white backlight illumination
- Image **center** cropped and magnified

- Image taken with a Basler acA2500-14gm camera
- 0.5 m working distance
- $f/2.8$ , white backlight illumination
- Image **corner** cropped and magnified

The images shown on this page are example images to illustrate the typical image quality of the referenced product only. The quality of the delivered product may vary.

## Revision History

Document Number	Date	Changes
DG00146501000	4 Feb 2015	Initial release of this document.
DG00146502000	28 Apr 2016	Set Asia-Pacific as region name. Updated the "Mechanical Specifications" table.